



# Safety Reel

## Guide

1991123XX – Cable reel, M (Electrical)



Edition C - 2025-02-05



User instructions:  
[www.cejn.com/safetyreel](http://www.cejn.com/safetyreel)

**EC Declaration of Conformity** – We declare that the products identified below:  
**Cable Reels Type 19 911 23XX** conforms to: **2006/42/EG, 2014/35/EG, SS-EN 61242\_1997/A2\_2016/C1, SS-EN\_61316**

**CEJN AB**  
 Rattvägen 1  
 SE-549 37 Skövde,  
 Sweden  
[www.cejn.com](http://www.cejn.com)

### 1. Safety



**WARNING!**

The products are intended for use by knowledgeable persons having the technical skill necessary to evaluate their suitability for specific applications. Read all safety instructions carefully before attempting to install, operate, or maintain this product. The cable reel may only be installed or repaired by a qualified technician (e.g. an electrician). The cable reel has a thermal overload protector and needs to be correct installed, otherwise there will be a high risk of electrical shock. This cable reel has undergone function and quality tests in accordance with SS-EN 61242\_1997/A2\_2016/C1 and SS-EN\_61316



Follow the specific national installation regulations. The reel is suitable for operating indoors and outdoors, IP44. When replacing the plug, only use a plug complying with IEC 60309-1 or IEC 60309-2, a minimum of 10A, IP44 may be used.

The cable reel and the cable must be checked for damage and wear regularly before each use. Any damage or defects must be repaired immediately. A broken cable must be replaced!

Equipment connected to the cable reel must not exceed the maximum permitted power consumption for the cable reel. Arbitrary modifications to the cable reel are forbidden for safety reasons.



**DANGER!**

Contact with live parts may cause electrical shock, injury or death! Never open the cable reel when it is connected to the mains. The power supply must always be disconnected before service or repairs.

### 2. Installation

For more detailed information regarding installing and operating of the reel, see our instruction videos at [www.cejn.com/safetyreel](http://www.cejn.com/safetyreel)

#### 2.1 Assembly

1

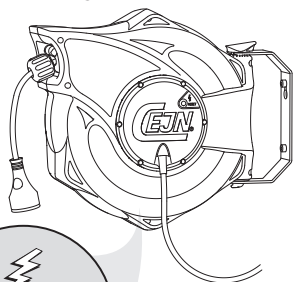

2

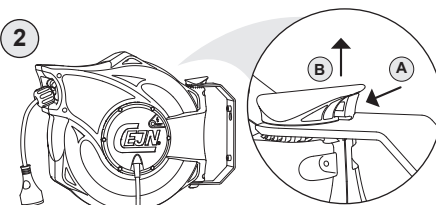

3

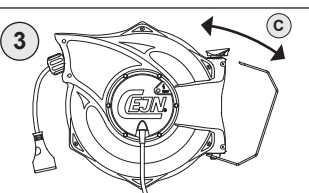

The cable reel must be installed so the work area is within the 180° range of wall bracket and fully extracted cable length

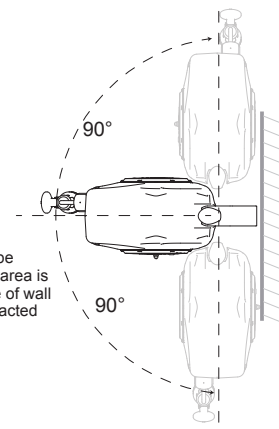

4

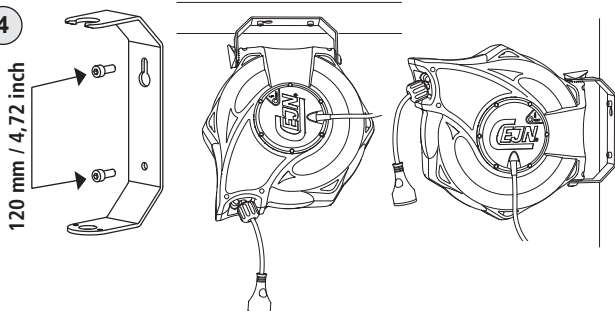

5

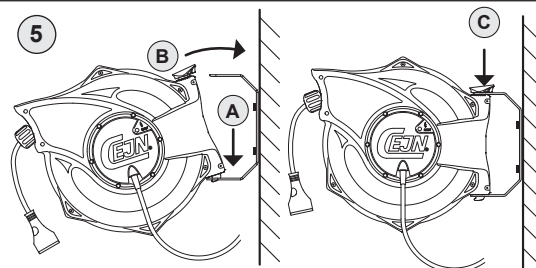

### 3. Operation

#### 2.2 Stop ball position

The stop ball is allowed to be moved inwards. The spring force requires no adjustment. See video instruction for further information at [www.cejn.com/safetyreel](http://www.cejn.com/safetyreel)

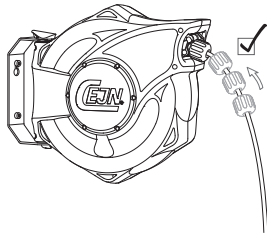

#### 3.1 Pulling out the cable

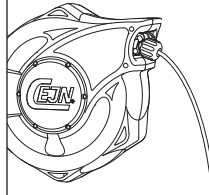

(1) Pull out the cable to the required length.

(2) To lock the cable, listen for the latch to engage with a "click" while slowly pulling out the cable a short distance.

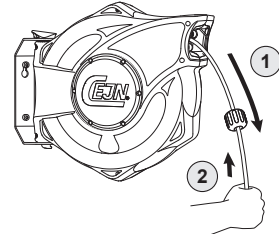

#### 3.2 Retracting the cable

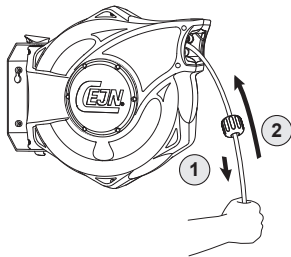

To unlock the cable when you have finished using it, (1) simply pull it out a short distance and listen for the latch to stop "clicking".

(2) Then let the cable slowly retract into the housing.

#### Slow retraction

The new Safety Reel is equipped with a sturdy centrifugal braking of the drum, combined with a strong spring force, giving a slow and firm retraction that keeps the working environment safe.

Since the brake contains wear parts, check the Safety reel regularly with regard to the brake function. If the braking effect is reduced, replace worn brake shoes with original spare parts.

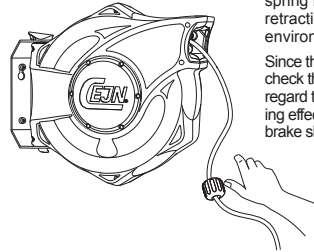

#### 3.3 The cable cannot be fully retracted

If the cable gets jammed when retracted, simply pull out the cable to its full length and let it retract freely without assistance. If you experience further problems or other malfunctions, contact your local distributor for guidance. See videos at [www.cejn.com/safetyreel](http://www.cejn.com/safetyreel) for more guidance

### 4. Malfunction/action

#### The connected equipment does not start or suddenly switches off and cannot be restarted

Make sure that the cable reel is connected to the mains. Check that all fuses are intact. If the fuse is intact, it is probably the heat-sensitive overload protection which has turned off the power supply to the cable reel. Make sure that the connected equipment is not overloading the cable reel. Before you turn the power supply back on, any connected equipment must be disconnected from the cable reel. Once the cable reel has cooled down, after about five minutes, you can press the reset button.

### 5. Maintenance



- Carry out regular checks that there are no problems with the cable, cable guiding and external parts.
- Any damage or defects must be repaired immediately.
- Repairs and maintenance must be carried out by a qualified technician only.
- Only original spare parts must be used!

### 6. Disposal/Recycling



**IMPORTANT!**  
Help us to take care of the environment. When disposing of the cable reel, please do so in accordance with local environmental regulations.



### 7. Warranty

CEJN AB provides a two (2) year warranty from the date of manufacture. Contact your retailer concerning warranty enquiries.

### 8. Spare parts

For safety reasons, only original spare parts must be used. For a complete overview of spare parts, see [www.cejn.com/safetyreel](http://www.cejn.com/safetyreel)

*Marcus Allerbjerg*

Marcus Allerbjerg  
CEJN AB